

BALTI 220 SURFACE

E5W000-

base number Finish
Options

- To build a product code in our configurator select the specify button on the base model # product page
- To build a manual product code on this datasheet choose from the options listed below in blue font and add the suffix to the base model #

GENERAL

Series: Balti _____
Subseries: Balti 220 _____
Brand: Ivela _____
Division: Exterior _____
Mounting Type: Surface _____
Mounting Location: Wall _____
Subcategory: Wall Effect _____

PHYSICAL

Shape: Rectangle _____
Length (mm): 225 _____
Length (in): 8 ⁷/₈ _____
Width (mm): 166 _____
Width (in): 6 ⁹/₁₆ _____
Height (mm): 225 _____
Height (in): 8 ⁷/₈ _____
Extension (mm): 56 _____
Extension (in): 2 ³/₁₆ _____
Light Distribution: Direct / Indirect _____
Weight (kg): 1.9 _____
Weight (lbs): 4.19 _____
Diffuser: Tempered Glass _____
Fixture Finish: MWH / SIL _____
Fixture Material: Aluminum Die Cast _____

ELECTRICAL

Lamp Type: LED _____
Total Output Wattage (W): 52 _____
Dimming: Non-Dimming / Phase Dimming (120vac Only) _____
Driver Included: Yes _____
Driver Location: Integrated _____
Driver Type: Constant Current - Universal _____
Driver Class: Class 2 _____
Input Voltage (V): 120 - 277 _____
Constant Current (MA): 700 _____
Upon Request: (See components [IP65 or higher enclosure to be supplied by others]) Remote: 0-10Vdc dimming _____

LED

Number of LEDs: 2 _____
Color Temperature (°K): 3000 _____
Max. Delivered Lumen (lm): 5596 _____
CRI: >85 CRI _____
Lamp Life (hrs): 50000 _____

OPTICAL

Reflector°: 100 / 100 _____

RATINGS AND CERTIFICATIONS

Certified By: Certified for North American Standards _____
IP rating: IP66 _____
IK Rating: IK09 _____

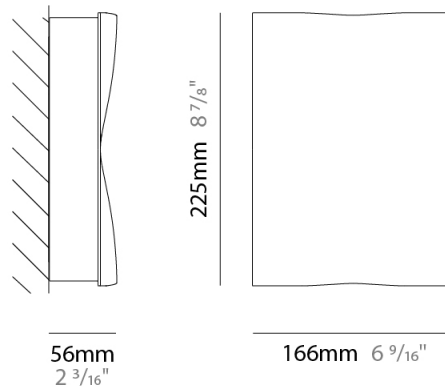

BALTI 220 SURFACE

E5W000-

PROJECT _____

TYPE _____

SPECIFIER _____

QUANTITY _____

DATE _____

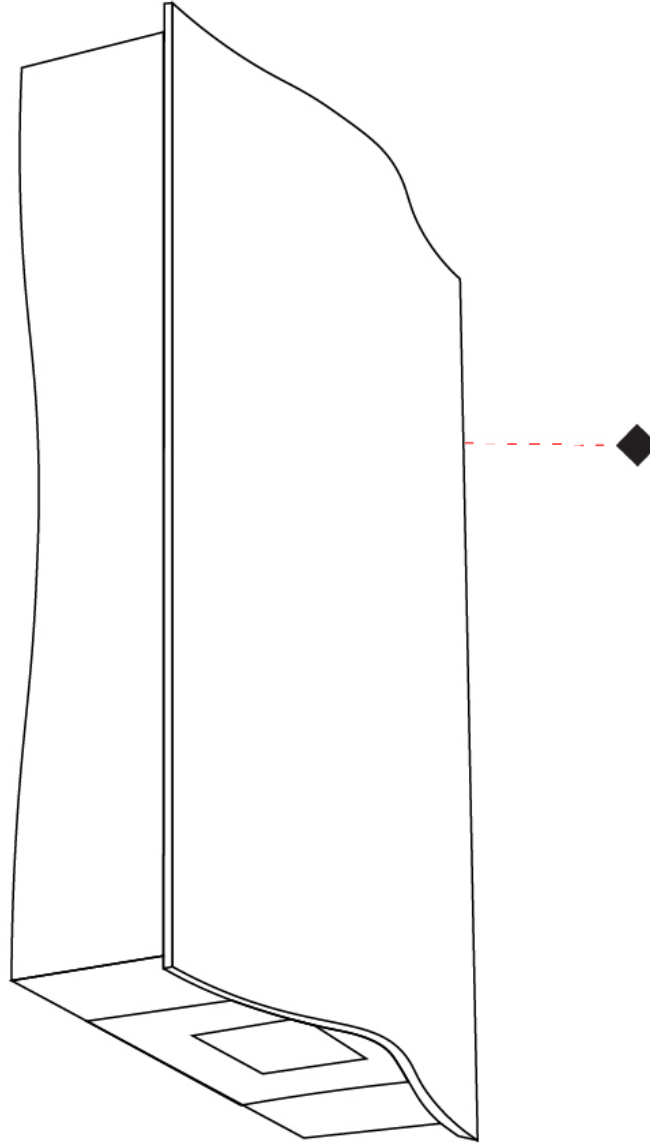

E

PROJECT
TYPE
SPECIFIER
QUANTITY
DATE

BALTI 260 SURFACE

E5W003-

base number Finish
Options

- To build a product code in our configurator select the specify button on the base model # product page
- To build a manual product code on this datasheet choose from the options listed below in blue font and add the suffix to the base model #

GENERAL

Series: Balti
 Subseries: Balti 260
 Brand: Ivela
 Division: Exterior
 Mounting Type: Surface
 Mounting Location: Wall
 Subcategory: Up/Down Light

PHYSICAL

Shape: Rectangle
 Length (mm): 264
 Length (in): 10 ³/₈
 Width (mm): 170
 Width (in): 6 ¹¹/₁₆
 Height (mm): 61
 Height (in): 2 ³/₈
 Extension (mm): 61
 Extension (in): 2 ³/₈
 Light Distribution: Direct / Indirect
 Weight (kg): 1.7
 Weight (lbs): 3.75
 Diffuser: Tempered Glass
 Fixture Finish: MWH / SIL
 Fixture Material: Aluminum Die Cast

ELECTRICAL

Lamp Type: LED
 Total Output Wattage (W): 36
 Dimming: Non-Dimming / Phase Dimming (120vac Only)
 Driver Included: Yes
 Driver Location: Integrated
 Driver Type: Constant Current - Universal
 Driver Class: Class 2
 Input Voltage (V): 120 - 277
 Constant Current (MA): 500
 Upon Request: (See components [IP65 or higher enclosure to be supplied by others]) Remote: 0-10Vdc dimming

LED

Number of LEDs: 2
 Color Temperature (°K): 3000
 Max. Delivered Lumen (lm): 4080
 CRI: >85 CRI
 Lamp Life (hrs): 50000

OPTICAL

Reflector°: 30 / 30

RATINGS AND CERTIFICATIONS

Certified By: Certified for North American Standards
 IP rating: IP66
 IK Rating: IK09

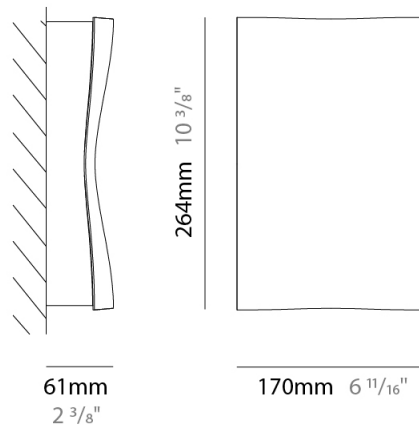

E5W003-

PROJECT

TYPE

SPECIFIER

QUANTITY

DATE

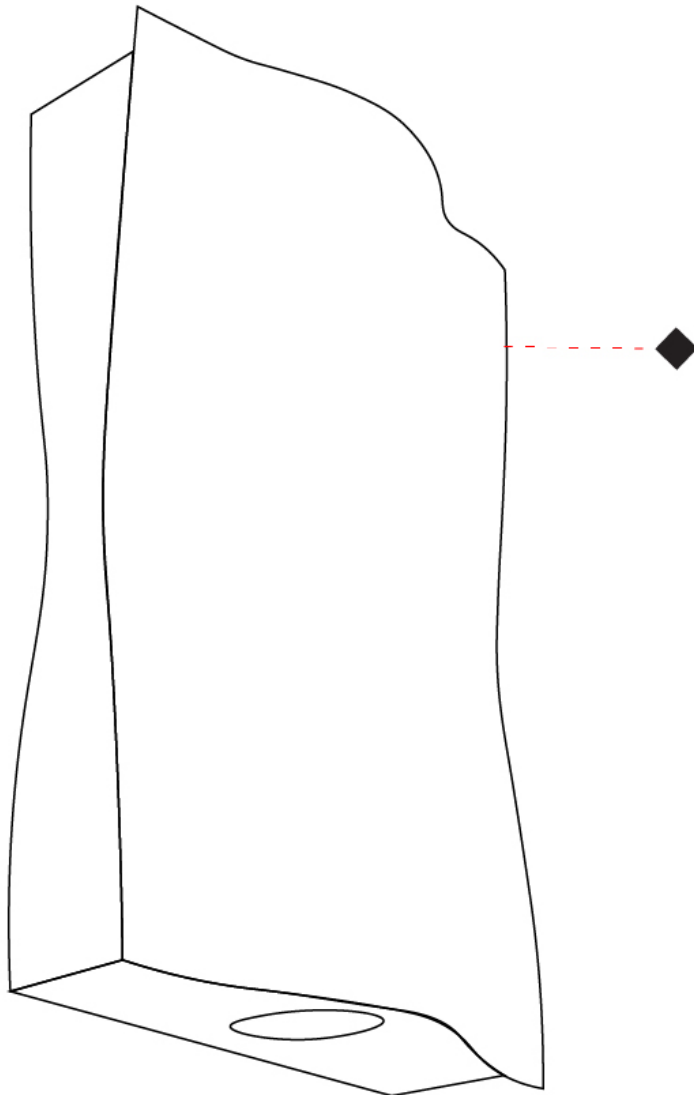

E

BALTI 150 SURFACE

E5W005-

base number Color Finish
 Temperature Options

PROJECT
TYPE
SPECIFIER
QUANTITY
DATE

- To build a product code in our configurator select the specify button on the base model # product page
- To build a manual product code on this datasheet choose from the options listed below in blue font and add the suffix to the base model #

GENERAL

Series: Balti
 Subseries: Balti 150
 Brand: Ivela
 Division: Exterior
 Mounting Type: Surface
 Mounting Location: Wall
 Subcategory: Wall Effect

PHYSICAL

Shape: Rectangle
 Length (mm): 158
 Length (in): 6 ¼
 Width (mm): 163
 Width (in): 6 ⅞
 Extension (mm): 48
 Extension (in): 1 ⅞
 Light Distribution: Direct
 Weight (kg): 1.1
 Weight (lbs): 2.42
 Diffuser: Tempered Glass
 Fixture Finish: MWH / SIL
 Fixture Material: Aluminum Die Cast

ELECTRICAL

Lamp Type: LED
 Total Output Wattage (W): 26
 Dimming: Non-Dimming / Phase Dimming (120vac Only)
 Driver Included: Yes
 Driver Location: Integrated
 Driver Type: Constant Current - Universal
 Driver Class: Class 2
 Input Voltage (V): 120 - 277
 Constant Current (MA): 700
 Upon Request: (See components [IP65 or higher enclosure to be supplied by others]) Remote: 0-10Vdc dimming

LED

Number of LEDs: 1
 Color Temperature (°K): 3000 / 3500
 Max. Delivered Lumen (lm): 2551
 CRI: >85 CRI
 Lamp Life (hrs): 50000

OPTICAL

Reflector°: 110
 Beam Angle: Asymmetric - wide
 Adjustability: Fixed

RATINGS AND CERTIFICATIONS

Certified By: Certified for North American Standards
 IP rating: IP66
 Upon Request: Dark Sky Certification

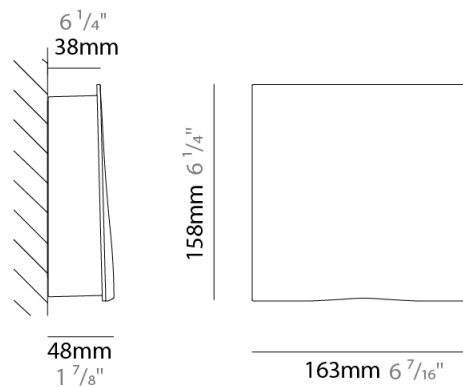

BALTI 150 SURFACE

E5W005-

PROJECT

TYPE

SPECIFIER

QUANTITY

DATE

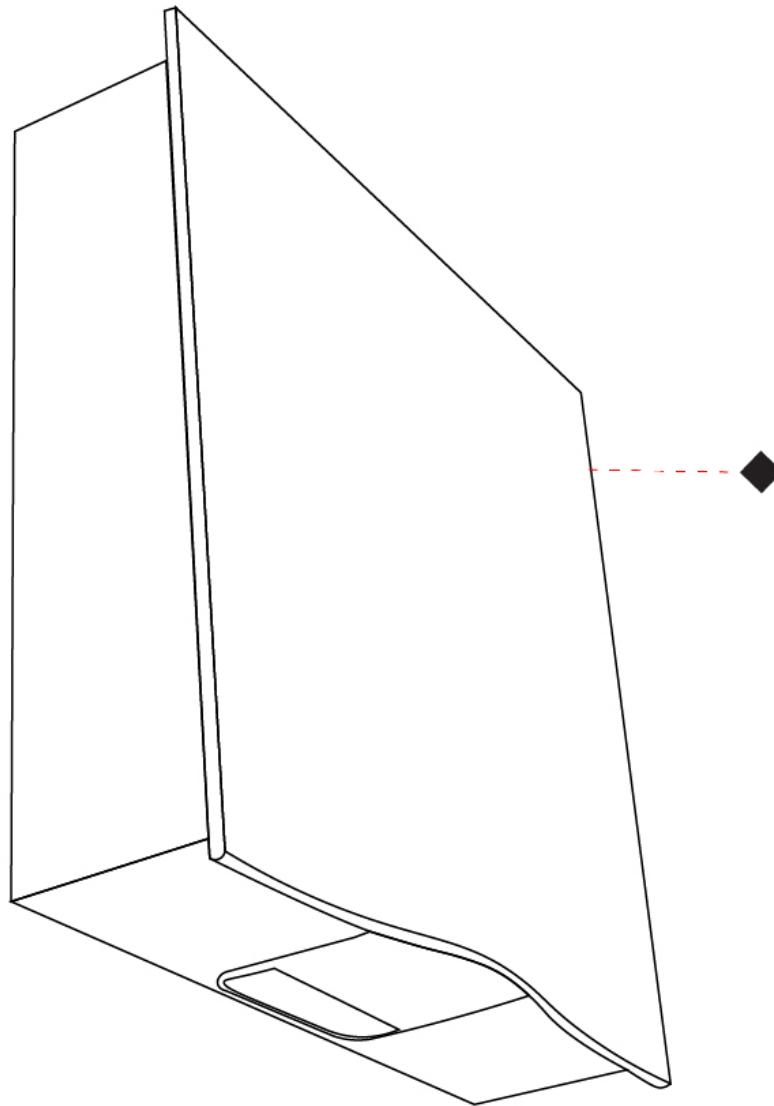

E

BALTI 150 SURFACE

E5W006- -

base number Color Finish
 Temperature Options

PROJECT
TYPE
SPECIFIER
QUANTITY
DATE

- To build a product code in our configurator select the specify button on the base model # product page
- To build a manual product code on this datasheet choose from the options listed below in blue font and add the suffix to the base model #

GENERAL

Series: Balti
 Subseries: Balti 150
 Brand: Ivela
 Division: Exterior
 Mounting Type: Surface
 Mounting Location: Wall
 Subcategory: Wall Effect

PHYSICAL

Shape: Rectangle
 Length (mm): 158
 Length (in): 6 1/4
 Width (mm): 163
 Width (in): 6 7/16
 Height (mm): 48
 Height (in): 1 7/8
 Extension (mm): 48
 Extension (in): 1 7/8
 Light Distribution: Direct
 Weight (kg): 1.1
 Weight (lbs): 2.42
 Diffuser: Tempered Glass
 Fixture Finish: MWH / SIL
 Fixture Material: Aluminum Die Cast

ELECTRICAL

Lamp Type: LED
 Total Output Wattage (W): 12
 Dimming: Non-Dimming / Phase Dimming (120vac Only)
 Driver Included: Yes
 Driver Location: Integrated
 Driver Type: Constant Current - Universal
 Driver Class: Class 2
 Input Voltage (V): 120 - 277
 Constant Current (MA): 350
 Upon Request: (See components [IP65 or higher enclosure to be supplied by others]) Remote: 0-10Vdc dimming

LED

Number of LEDs: 1
 Color Temperature (°K): 3000 / 3500
 Max. Delivered Lumen (lm): 1348
 CRI: >85 CRI
 Lamp Life (hrs): 50000

OPTICAL

Reflector: 110
 Beam Angle: Asymmetric - wide

RATINGS AND CERTIFICATIONS

Certified By: Certified for North American Standards
 IP rating: IP66
 Upon Request: Dark Sky Certification

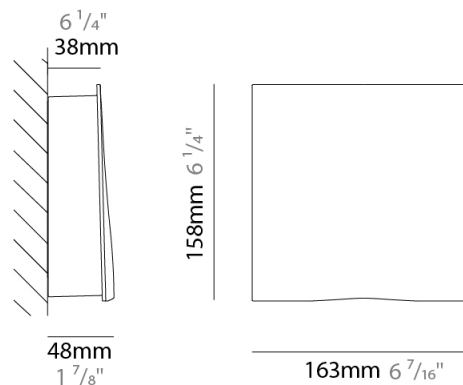

BALTI 150 SURFACE

E5W006-

PROJECT

TYPE

SPECIFIER

QUANTITY

DATE

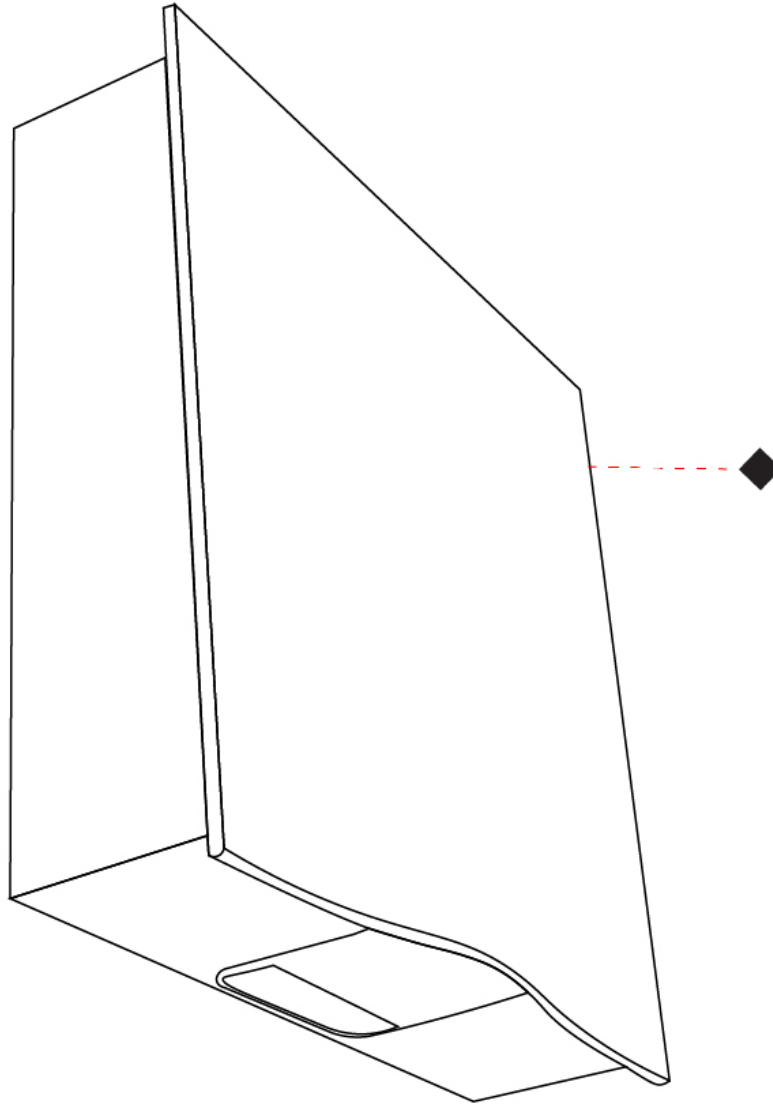

E

BALTI

COLOR FINISH CHART

PROJECT

TYPE

SPECIFIER

QUANTITY

DATE

Fixture Finish

Matte White - MWH



Silver - SIL

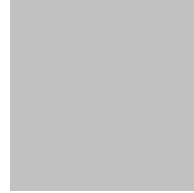





































































Digital: Not all screens are calibrated the same, and therefore, colors will appear differently between screens.

Physical: When texture is involved, there will be variations in color, character and tone within a product series and between product families.













PROJECT	
TYPE	
SPECIFIER	
QUANTITY	
DATE	











LEGEND

 floor-mounted	 pivotable	 special LED (upon request) RGB, RGBW, tunable, gold+, meat+, art+, fashion+
 wall and ceiling: recessed and surface mounted	 rotating	 warm dim / natural dimming LED
 ceiling-mounted and wall-mounted	 illuminate tilted	 rechargeable battery powered
 wall-mounted	 color of suspension cable	 fixture with natural vivid LED (upon request)
 omni-directional light distribution	 length of suspension cable	 color rendering index
 direct light distribution	 reflector degree selection	 color temperature
 direct/indirect light distribution	 super spot	 lumen (luminous flux)
 indirect light distribution	 lens	 efficacy (lumens per watt)
 asymmetric light distribution	 lens pack	 Unified Glare Rating (UGR) range from 5-40
 aura light distribution	 shine ring	 marine grade (AISI 316 stainless steel)
 round wall or ceiling cut-out	 integrated shine ring with diffuser	 walk on
 square wall or ceiling cut-out	 free individual colors 01-29	 drive on
 the supplied jig specifies the cutout dimensions	 individual colors: 00 (free of charge), 01-25 (extra charge)	 Dark Sky Compliance
 minimum distance (meters) lamp - object	 luminaire part to be colored (F1)	 Americans with Disabilities Act (less than 4" off the wall located between 27"-84" from floor)
 recessed depth	 luminaire part to be colored (F2)	 lamp protected against explosion
 ceiling thickness in mm	 luminaire part to be colored (F3)	 blown glass using traditional methods by master glass blower
 ceiling thickness selection	 luminaire part to be colored (F4)	 acoustic material
 dimmable DP (phase), DV (0-10V), DD (dali), DS (step-dim)	 luminaire part to be colored (F5)	 protection class I, protection insulation
 included or excluded LED driver/transformer/control gear	 color of 3-circuit adaptor	 protection class II, protection insulation
 separately switchable	 indirect diffuser	 ETL Certified to UL and CSA Standards
 sensor	 direct diffuser	 UL Certified to UL and CSA Standards
 remote control	 ball-proof (upon request)	 CSA Certified to UL and CSA Standards
 available upon request	 accessory	 Certified for North American Standards

IP RATING

 IP20	protected against ingress of solid bodies greater than 12.5mm (finger)
 IP33	protected against ingress of solid bodies greater than 2.5mm protected against sprays of water up to 60 degrees from the vertical (rain)
 IP40	protected against ingress of solid bodies greater than 1mm (wire) no protection against the ingress of moisture
 IP43	protected against ingress of solid bodies greater than 1mm (wire) protected against sprays of water up to 60 degrees from the vertical (rain)
 IP44	protected against ingress of solid bodies greater than 1mm (wire) protected against water splashed from all directions
 IP54	protected against limited ingress of dust (wet rooms/covered outdoor areas) protected against water splashed from all directions
 IP65	protected against ingress of dust protected against jets of water
 IP66	protected against ingress of dust protected against powerful jets of water or heavy seas
 IP67	protected against ingress of dust protected against immersion of water between 15cm - 1m for 30 minutes
 IP68	protected against ingress of dust protected against immersion of water under pressure for long periods

IK RATING

 IK01	protected against 0.14 joules impact (equivalent to 0.25kg mass dropped from 56mm above the surface)
 IK02	protected against 0.2 joules impact (equivalent to 0.25kg mass dropped from 80mm above the surface)
 IK03	protected against 0.35 joules impact (equivalent to 0.25kg mass dropped from 140mm above the surface)
 IK04	protected against 0.5 joules impact (equivalent to 0.25kg mass dropped from 200mm above the surface)
 IK05	protected against 0.7 joules impact (equivalent to 0.25kg mass dropped from 280mm above the surface)
 IK06	protected against 1 joules impact (equivalent to 0.25kg mass dropped from 400mm above the surface)
 IK07	protected against 2 joules impact (equivalent to 0.5kg mass dropped from 400mm above the surface)
 IK08	protected against 5 joules impact (equivalent to 1.7kg mass dropped from 300mm above the surface)
 IK09	protected against 10 joules impact (equivalent to 5.0kg mass dropped from 200mm above the surface)
 IK10	protected against 20 joules impact (equivalent to 5.0kg mass dropped from 400mm above the surface)